

## SPECIFICATIONS

UL, CUL CERTIFICATE

INTERNAL DRIVER, INPUT VOLTAGE 200-480vac

NO UV OR IR IN THE BEAM

EASY TO INSTALL AND OPERATE

LONG LIFESPAN

LIGHT IS SOFT AND UNIFORM, SAFE TO EYES

INSTANT START, NO FLICKERING, NO HUMMING

GREEN AND ECO-FRIENDLY WITHOUT MERCURY



AM

DM

YM

A&D

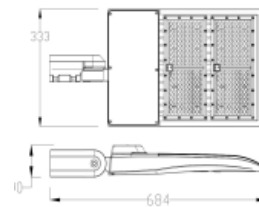

AM

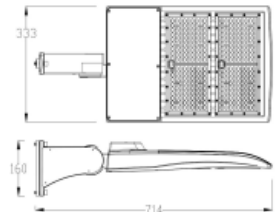

DM

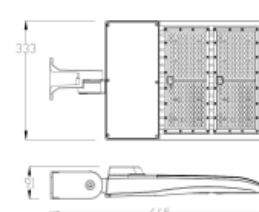

YM

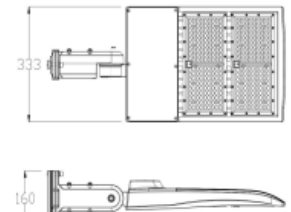

A&D

mm

## APPLICATIONS

STADIUM

SCHOOL PLAYGROUND

ENTERTAINMENT PLAZA

PARKING LOT



# 300 Watt Shoebox

ORDER INFORMATION						
SERIES	WATTAGE	VOLTAGE	COLOR	VIEWING	KELVIN	
		UH = 200-480V	BROWN	ANGLE	50=5000K	
CPS-SBX-	300W	UH	BR	T3	40	
					50	
EXAMPLE: CPS-SBX-300W-UH-BR-T3-50						
UL PART# CPS-SBX-300W-UH-a-Y-bcef				File No. E363936		
DLC PART# CPS-SBX-300W-UH-a-T3-[P;blank][S;blank]e50						
A&D MOUNT COMES STANDARD WITH ALL SHOEBOX UNITS. PLEASE SPECIFY IF DIFFERENT MOUNTING OPTION IS NEEDED. OTHER OPTIONS INCLUDE: YOKE MOUNT (YM), ADJUSTABLE MOUNT (AM) AND DIRECT MOUNT (DM).						

TECHNICAL CHARACTERISTICS	
COLOR TEMPERATURE	4000K, 5000K
INPUT VOLTAGE	200-480V 50/60Hz
LUMENS	37500-42000LM
LUMEN EFFICIENCY	125-140 LM/W
WATERPROOF RATING	IP65
CRI	>70
PFC	>0.9
VIEWING ANGLE	150*85 (T3)
OPERATING TEMPERATURE	~20°C TO 40°C
OPERATING HUMIDITY	20%-90% RH
STORAGE TEMPERATURE	~30°C TO 80°C
STORAGE HUMIDITY	10%-95%
APPLICATION	OUTDOOR
PRODUCT DIMENSION	AM: 684*333*90 mm DM: 714*333*160 mm YM: 665*333*91 mm A&D: 746*333*160 mm
L70 LIFE	PROJECTED 100,000 HOURS
WARRANTY	10 YEARS

MATERIALS	
HOUSING	ALUMINUM
HOUSING COLOR	BROWN (STANDARD)

## PHOTOMETRIC:

### Luminaire Property

Luminaire Manufacturer:  
Voltage: 199.3 V  
Power: 291.64 W

Current: 1.5067 A  
Power Factor: 0.9678

### Photometric Results

IES Classification: Type III  
Total Rated Lamp Lumens: 36705.8 lm  
Efficiency: 100%  
Upward Ratio: 0%  
Central Intensity: 9113.72 cd  
Pos of Max. Intensity: H157.5 V73

Longitudinal Classification: Medium  
Measurement Flux: 36705.8 lm  
Downward Ratio: 100%  
Luminaire Efficacy Rating (LER): 125.86  
Max. Intensity: 12847.11 cd

Luminous Intensity Distribution Curve

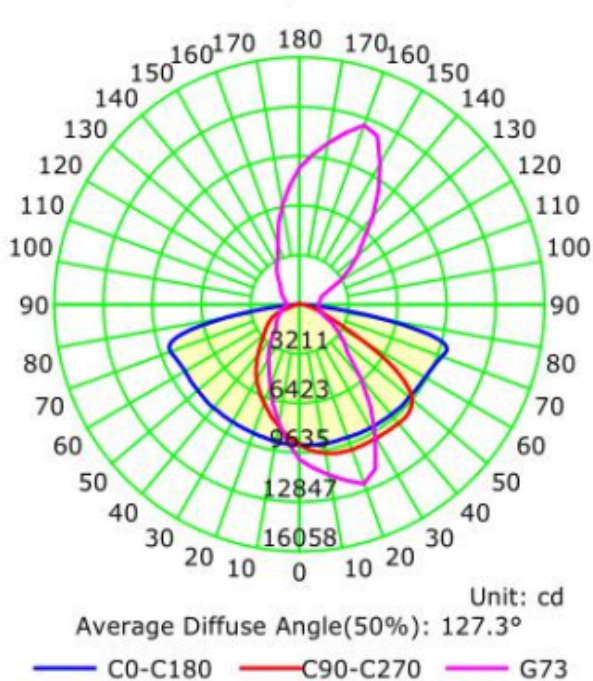

The Average Illuminance Effective Figure

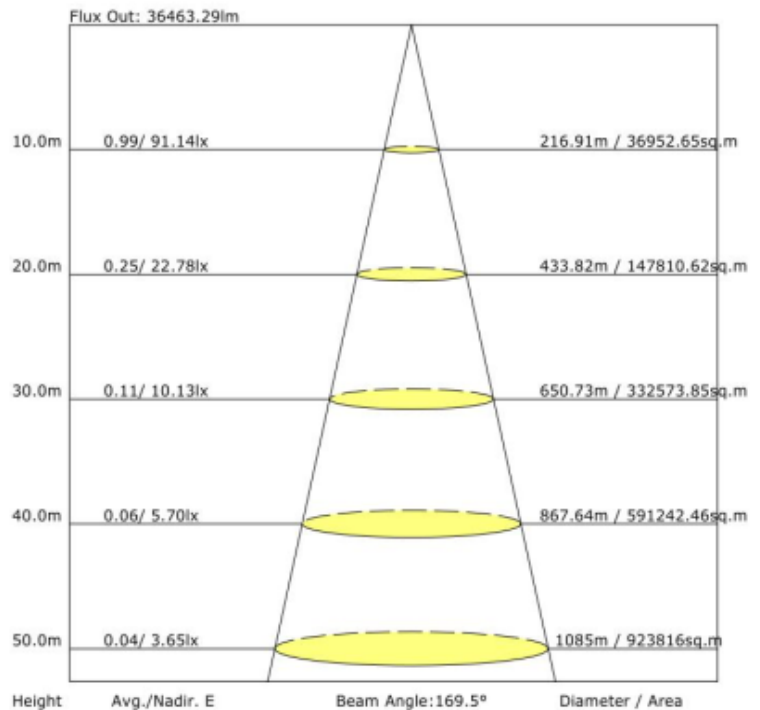



## PACKAGING

	SIZE	QTY/ CARTON	NET WEIGHT/ CARTON
OUTER BOX AM	755*385*160 MM	1 PCS	9.3 KG
OUTER BOX DM	755*385*160 MM	1 PCS	9.8 KG
OUTER BOX YM	755*385*160 MM	1 PCS	9 KG
OUTER BOX A&D	755*385*160 MM	1 PCS	10.1 KG

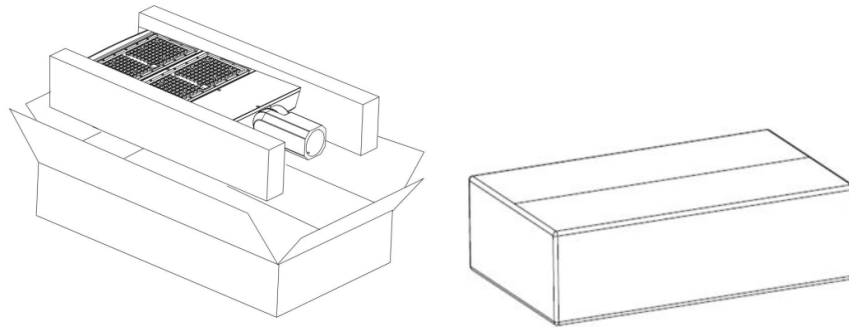

### NOTICE FOR USER:

Please turn off power before install or change assembly parts.

The input voltage and lamps should be matched, after connecting the power line.

Please make sure the wiring section is insulated.