

Specifications

Description: 2*4 LED Flat Panel Light
 Power: 40W
 Voltage: 100-277Vac
 Lumen Output: 4400lm
 Color Temperature: 3000K, 4000K, 5000K
 CRI: 80
 Lumen efficacy: 110lm/w
 Operating Temp.: -25 degree to 50 degree
 IP Rating: IP20
 Power Factor: > 0.95
 THD: < 20
 Certificate: ETL/cETL, DLC
 Warranty: 7 years
 L70 Life: Projected 100,000 hours
 Dimmability: 0-10V dimmable
 Dimension: 23.7"*47.4"*1"
 Weight: 10.6 kgs

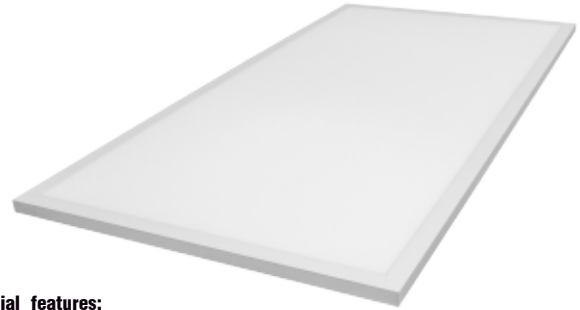

Special features:

switch to change CCT to one of 3000K, 4000K, 5000K

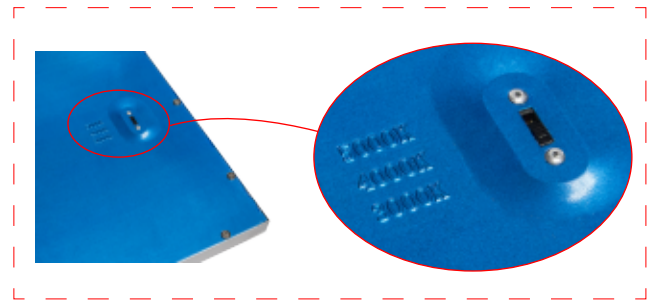

Model: CPS-PL-2X4-40W-UL-XX

Lux Chart

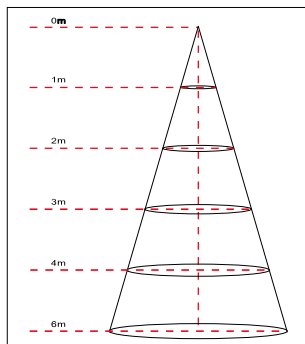

Height	Average Lux(lx)	Light range(dia.)
1M	1345.6	293.9cm
2M	336.4	587.8cm
3M	149.5	881.6cm
4M	84.1	1175.5cm
6M	37.4	1763.3cm

Photometrics

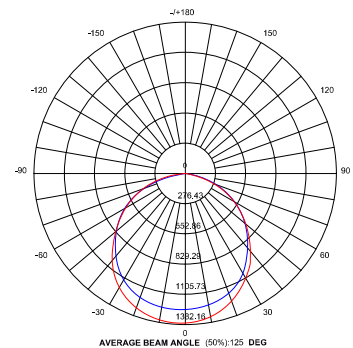

Order Information

Item Number	Description	Power	Voltage Input	Dimmable	CCT	Lumen Output	Certificates
CPS-PL-2X4-40W -UL-XX	2 x 4' LED Flat Panel light	40W	100-277Vac	Yes	3000K 4000K 5000K	4400lm	ETL/cETL,DLC

Packaging

4pcs/CTN G.W.:45 kg Dimension: 50"L x 26"W x 7"H (1275mmx655mmx176mm)

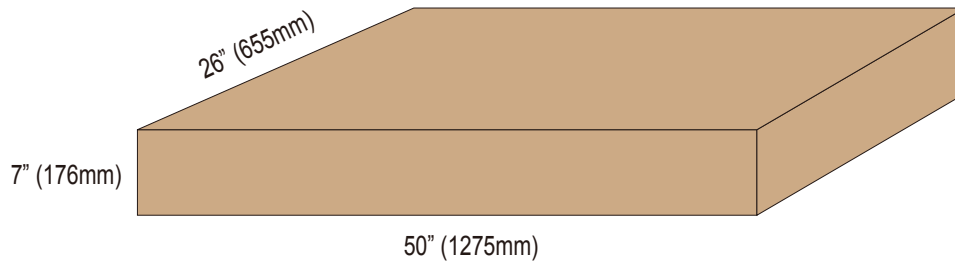

Safety Information

For your safety, always remember to:

- Turn off the power supply at the fuse or circuit breaker box before you install the fixture.
- Ground the fixture to avoid potential electric shocks and to ensure reliable starting.
- Double-check all connections to be sure they are tight and correct.
- Wear rubber soled shoes and work on a sturdy wooden ladder.
- Account for small parts and destroy packing material, as these may be hazardous to children



WARNING: RISK OF SHOCK. House electric current can cause painful shock or serious injury unless handled properly.



CAUTION: Turn off the main power at the circuit breaker before installing the fixture, in order to prevent possible shock.

NOTICE: All electrical connections must be in accordance with local and National Electrical Code (N.E.C.) standards. If you are unfamiliar with proper electrical wiring connections, obtain the services of a qualified electrician.

Remove the fixture and the mounting package from the box and make sure that no parts are missing by referencing the illustrations on the installation instructions.

INSTALLATION

CAUTION: Before beginning installation turn off the circuit breaker and light switch.

FLUSH MOUNT INSTALLATION

STEP 1

Place mounting plate (AA) over junction box and align holes. Route source wires from the junction box through hole in mounting plate (AA). Temporarily affix mounting plate (AA) with screws, determine correct orientation for light and then using a pen or marker, make marks at each of holes on mounting plate (AA). Remove mounting plate (AA).

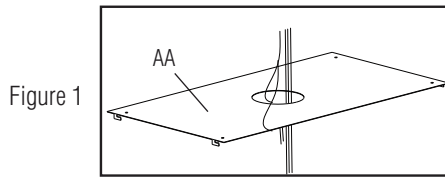

Figure 1

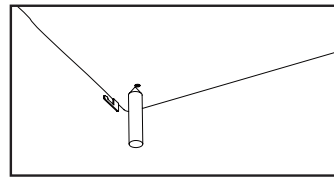

Figure 2

STEP 2

When mounting into drywall, predrill holes using a 1/2" drill bit. Insert drywall anchors (BB) into predrilled holes. Reattach mounting plate (AA) (mounting clips facing downward), attach mounting plate (AA) to junction box and insert screws (CC) through holes to secure to previously installed wall anchors (BB).

When mounting into a wooden surface, use screws (CC) at marked locations and follow process in step 2 to reattach mounting plate (AA).

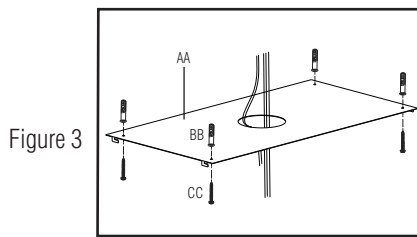

Figure 3

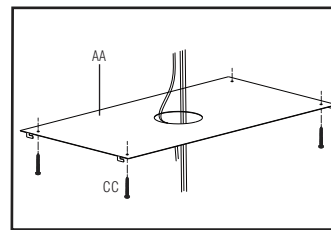

Figure 4

STEP 3

Securing the Toggle Bolts and Re-attaching the Mounting Plate

- Remove the wing from the toggle bolt (FF). Insert screw through front of mounting plate (AA) and re-attach the wing to the screw. Repeat for rest three toggle bolts (See Fig.5.1).
- Re-attach the mounting plate (AA) to the outlet box by inserting the four toggle bolts (FF) into the drilled holes. Once the wings are through and expanded, pull the screws from the toggle bolts (FF) downward to engage and tighten (Fig.5.2, Fig.5.3).

Note: When installing the panel light on a vertical surface (See Fig. 5.4), the mounting plate must be installed in such a way that the mounting tabs are oriented in a vertical position. If the mounting tabs are not in this position, the fixture will not be properly secured and could fall resulting in serious injury.

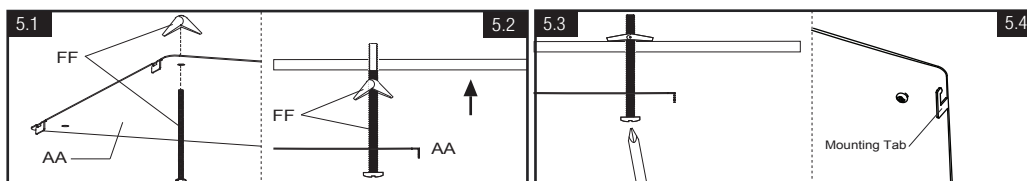

Figure 5

INSTALLATION

STEP 4 Refer to Figure 6 to properly wire panel light.

Recommended: Use electrical tape to cover wire nuts.

Optional Changeable Color Temperature (CCT): Turn the switch to the position of 3000K, 4000K, 5000K to select the color temperature.

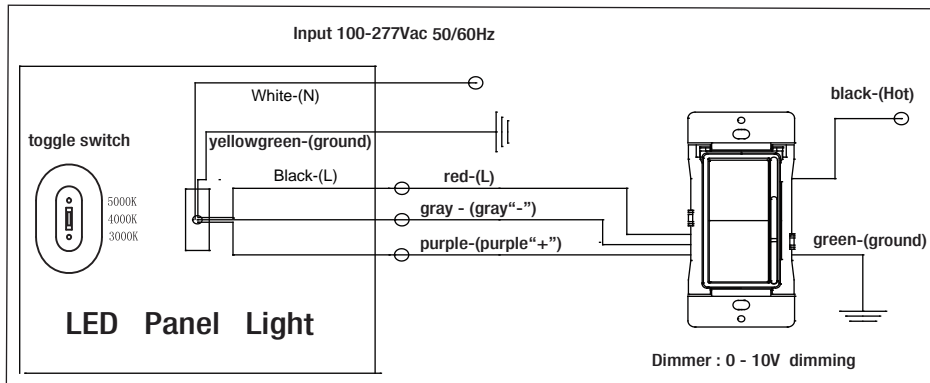

Figure 6

STEP 5

Install panel light by aligning locking tabs to recess areas on the panel light. Be sure to follow the orientation arrows on the panel light to ensure proper connection. Slide light into place to lock. Remove the alignment arrow markings once in place. (Figure 7)

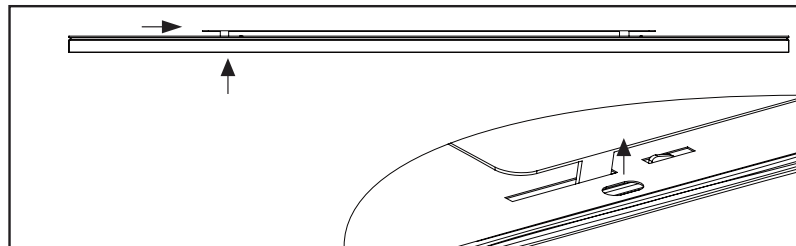

Figure 7

RECESSED MOUNT / T-GRID INSTALLATION

STEP 1

If replacing the existing luminaire, please remove the existing luminaire and leave a matching vacancy. If the new installation, remove the matching size of the ceiling panel and ensure ceiling wiring is properly available and routed to open location.

STEP 2

Refer to Figure 5 to properly wire panel light.

Recommended: Use electrical tape to cover wire nuts.

STEP 3

Once wired, take panel light and route through ceiling tile, mount one end of panel light on grid and lower other end until firmly in place. (Figure 8)

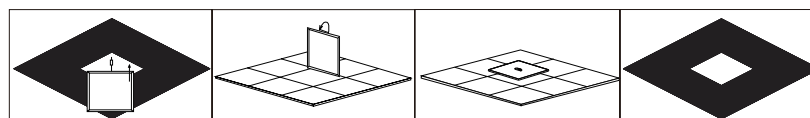

Figure 8